

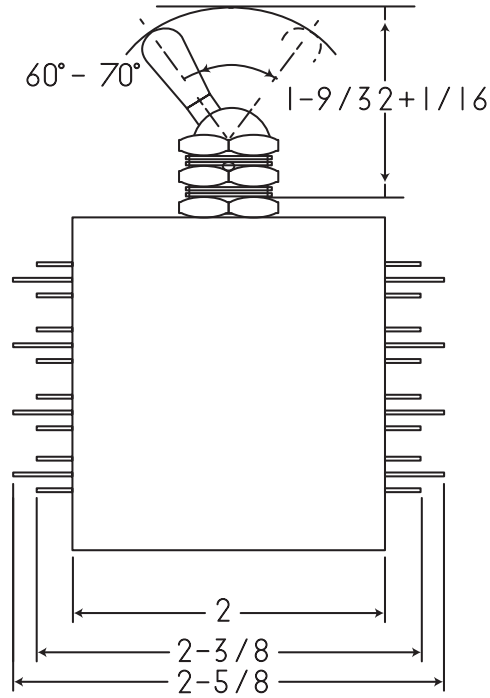

# ENVIRONMENTALLY-SEALED TOGGLE SWITCHES

832/932 TECHNICAL DIAGRAM 01

POSITION TO CLOSE  
NORMALLY CLOSED  
CONTACTS



**ALTERNATE  
TOGGLE DIRECTION  
(-I OPTION)**

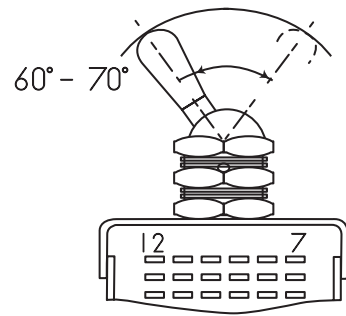



# ENVIRONMENTALLY-SEALED TOGGLE SWITCHES

## 832/932 TECHNICAL DIAGRAM 02

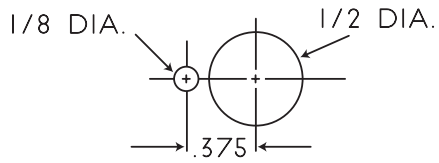

PANEL CUTOUT FOR TOGGLE SWITCH

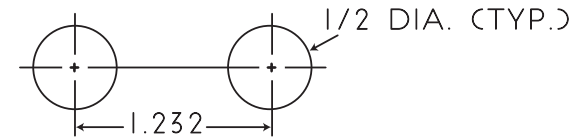

PANEL CUTOUT FOR TOGGLE SWITCH

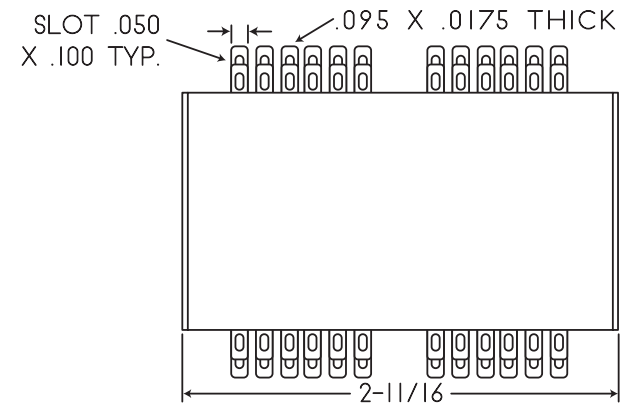
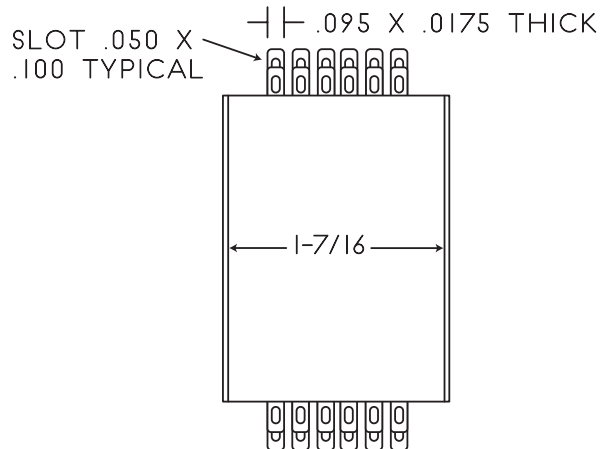
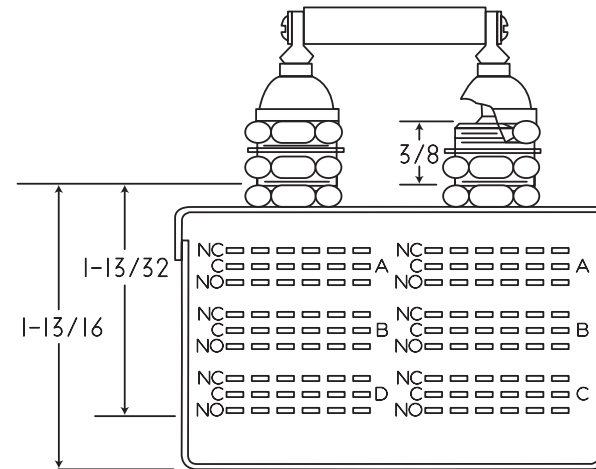
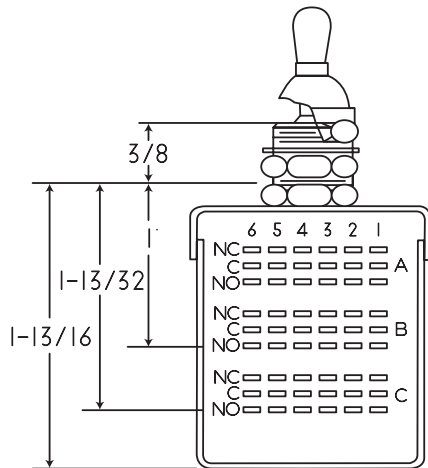



# ENVIRONMENTALLY-SEALED TOGGLE SWITCHES

## 832/932 TECHNICAL DIAGRAM 03

